

Multi-physical characterization and simulation of battery cells for predicting abuse scenarios

Martin Schwab

Battery Day 2022

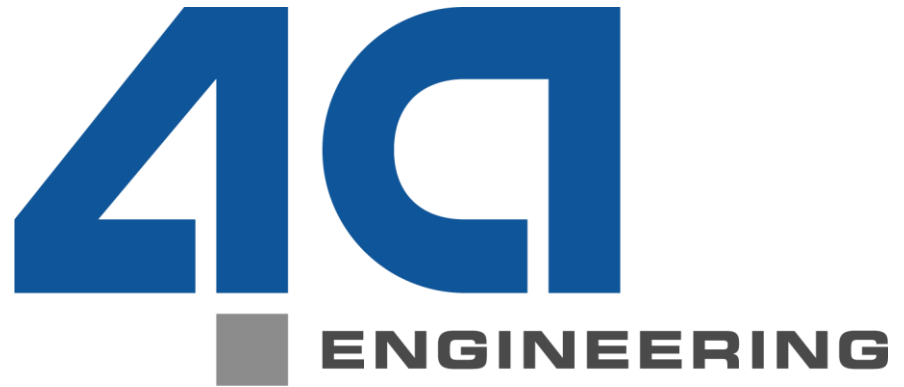

excellence in ...
plastics simulation
testing equipment
lightweight products



Outline

1. Generation of abuse simulation models of a single battery cell using LS Dyna
2. Abuse testing and simulation of a single battery cell
3. Application of a single cell model within the simulation of multi-cell mockups
4. Conclusion and outlook

Generation of abuse simulation models of a single battery cell using LS Dyna

Multiphysics of battery cells

Thermal

ρ
 λ
 \underline{q}
 T
 p
 k

T
 x
 k_1
 k_2
 k_3

Mechanical

T_{11} in MPa
 t in s
 F
 $\underline{\underline{\epsilon}}$
 u
 $\underline{\underline{T}}$
 $\underline{\underline{\sigma}}$

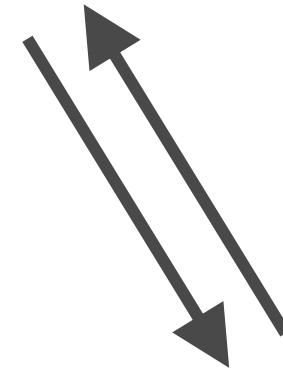
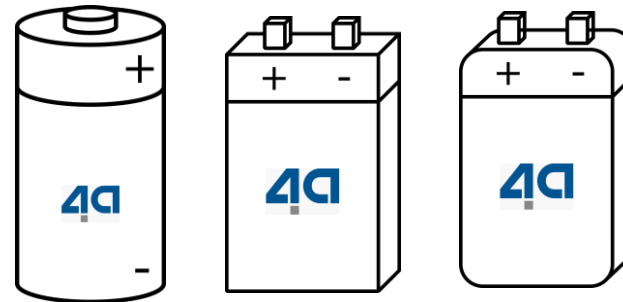

Electromagnetical

R
 U
 I
 C
 SOC

Modeling approaches in LS DYNA

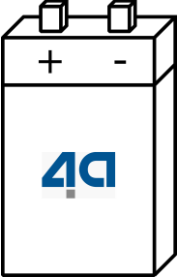
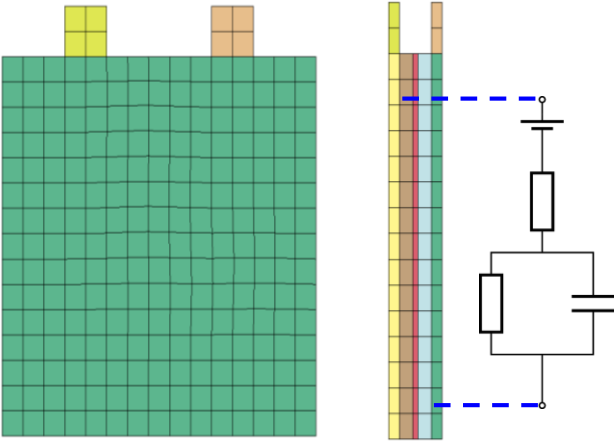
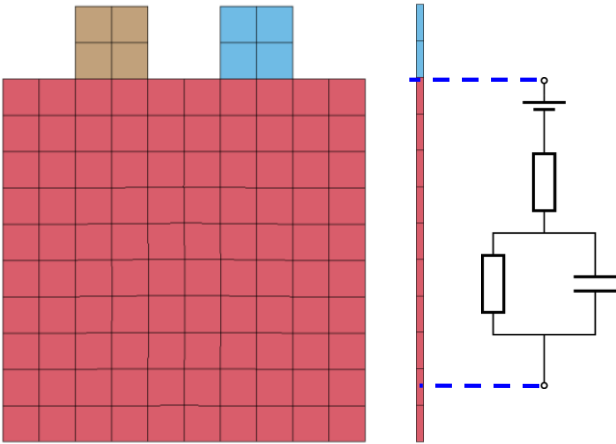
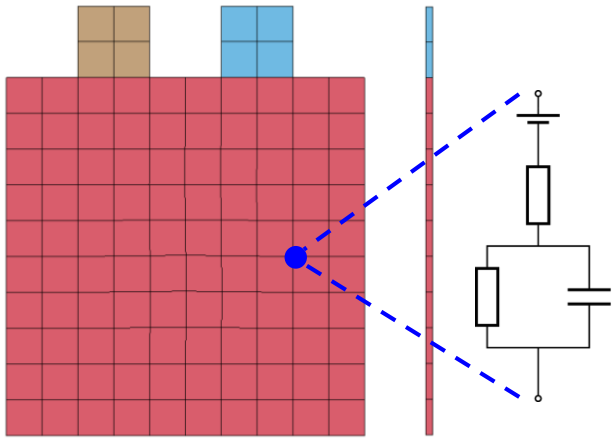
	Solid layer model	Tshell model	Batmac model
			
Keyword	*EM_RANDLES_SOLID	*EM_RANDLES_TSHELL	*EM_RANDLES_BATMAC
Characteristics	<ul style="list-style-type: none"> + Analysis of the different layers is possible - Computational effort 	<ul style="list-style-type: none"> + Beneficial modeling of thin cells - Behavior of the layers can not be analyzed in detail 	<ul style="list-style-type: none"> + Modeling with respect to mechanical and thermal problem - Behavior of the layers can not be analyzed

Electrical modelling and characterization

- electrical behavior is covered by a circuit model

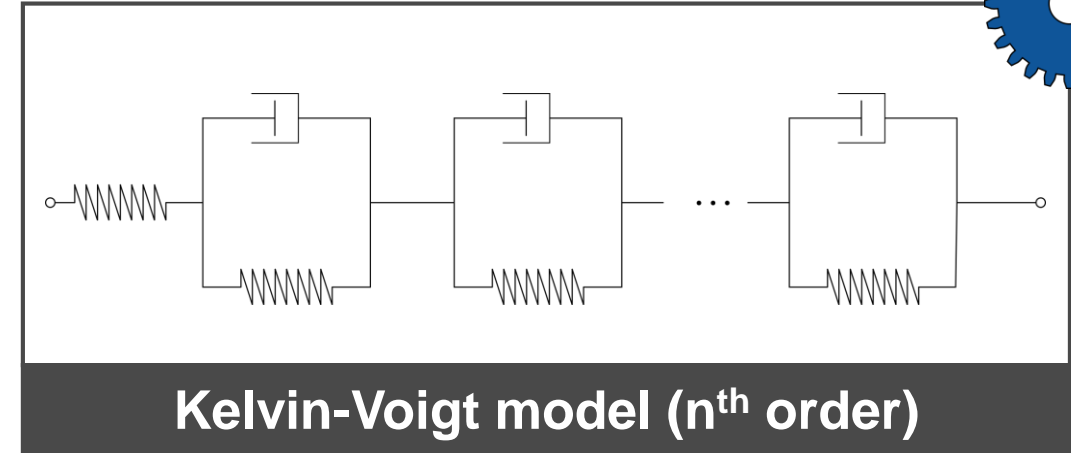
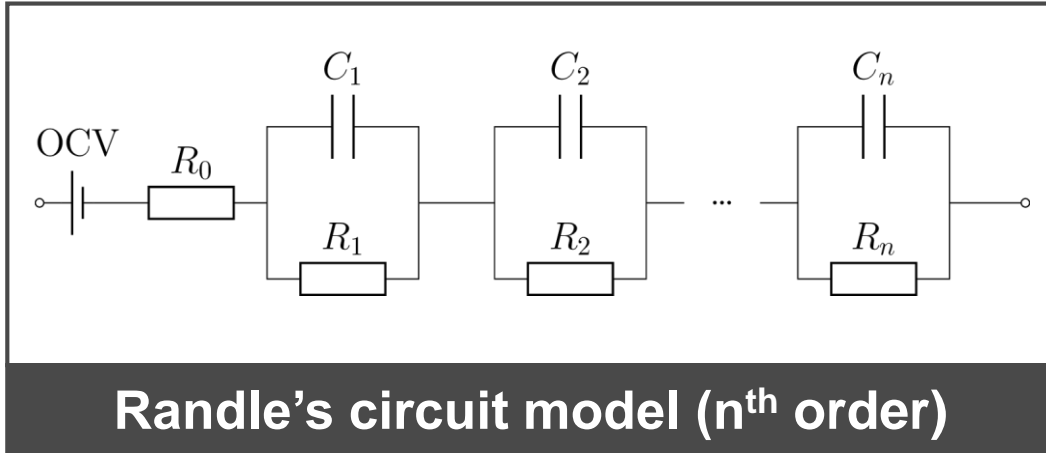

- parameter as well as the OCV-SOC curve are identified from the 4a HPPC test

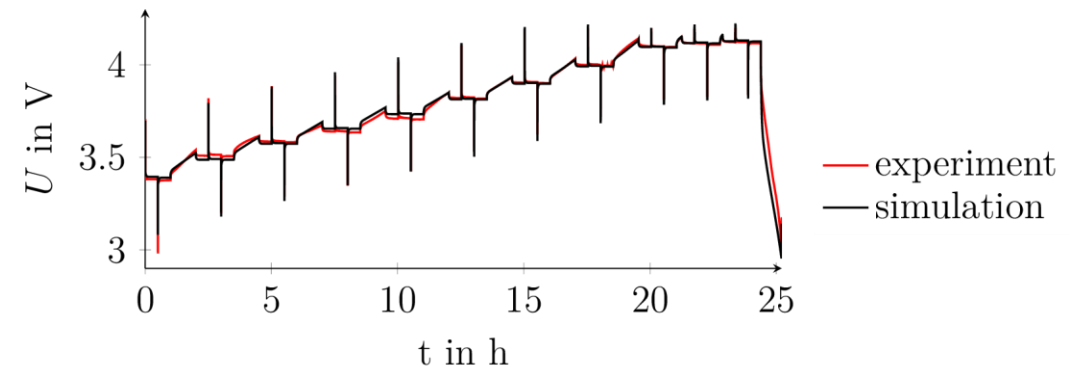
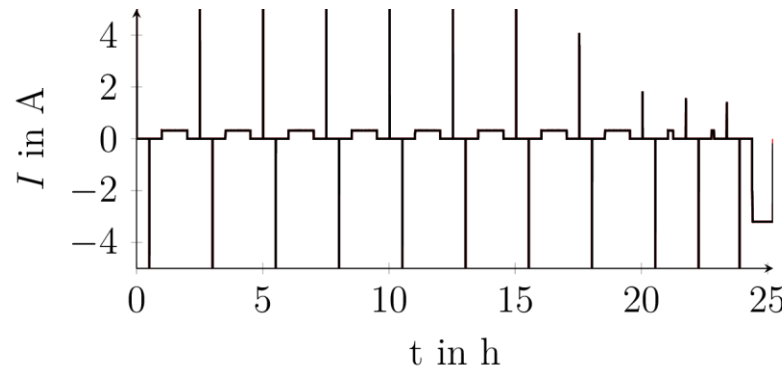
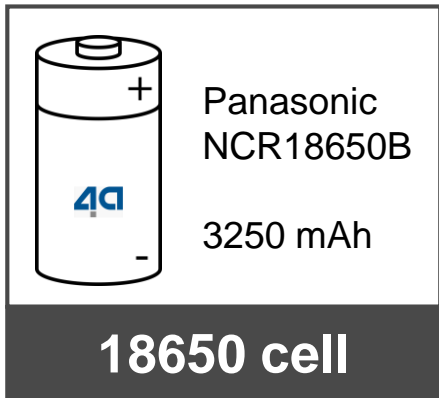

Characteristic of the abuse of a battery cell

- Course of voltage and temperature because of overheating

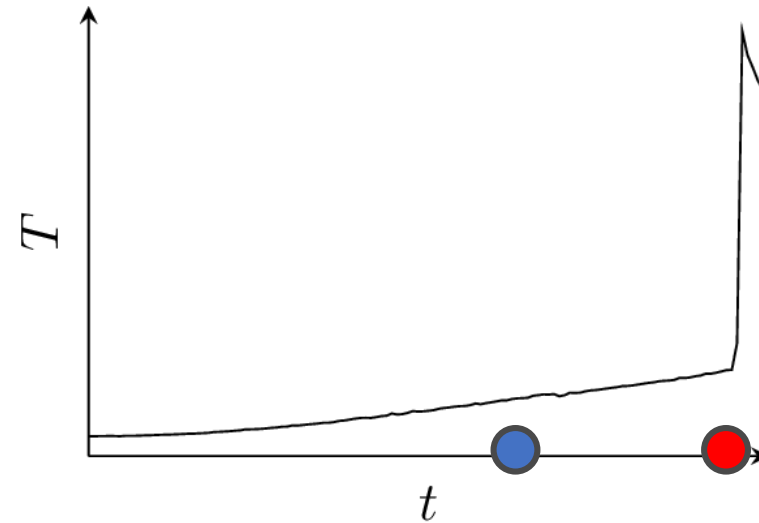
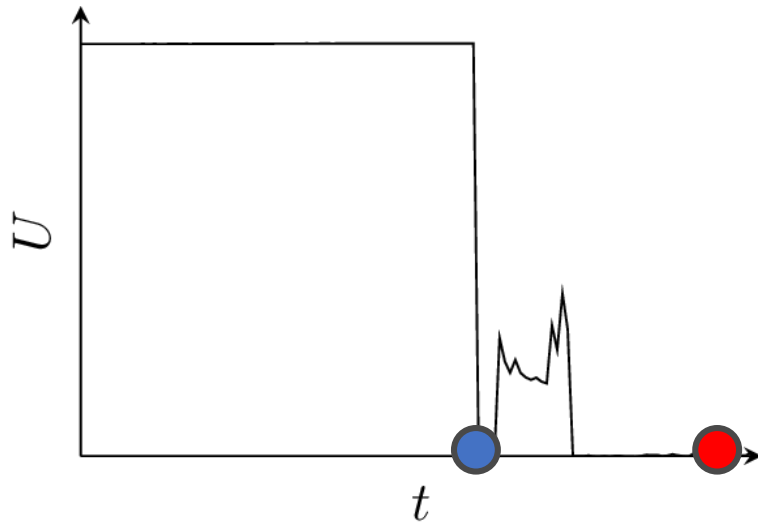

- Characteristic points and effects:
 - **Internal short circuit:** drop of the voltage
 - **Exothermic reaction:** spontaneous increase of the temperature

Abuse simulation of a single cell

- Modeling of the internal short circuit and the exothermal reaction

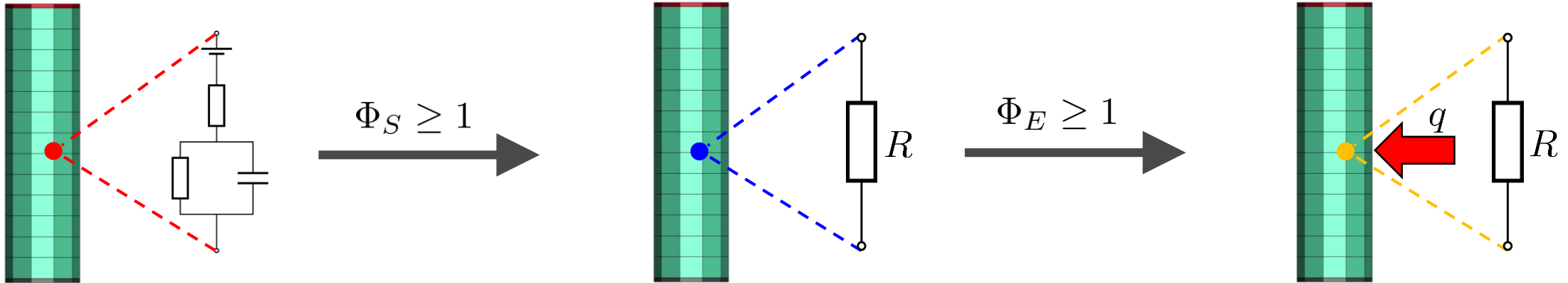

Initiation criterion:

$$\Phi_S (T, \text{SOC}, \underline{\underline{\varepsilon}}) \geq 1$$

Short resistance:

$$R = \text{const.}$$

Internal short circuit

Initiation criterion:

$$\Phi_E (T) \geq 1$$

Additional heat source:

$$q (T)$$

Exothermal reaction

Abuse testing and simulation of a single battery cell

Overheat test of a single battery cell

- Overheating of a fully charged 18650 battery cell (Panasonic NCR18650B) at the bottom
- Measurement of the temperature at the cell as well as in the chamber with 6 thermocouples
- Measurement of the voltage

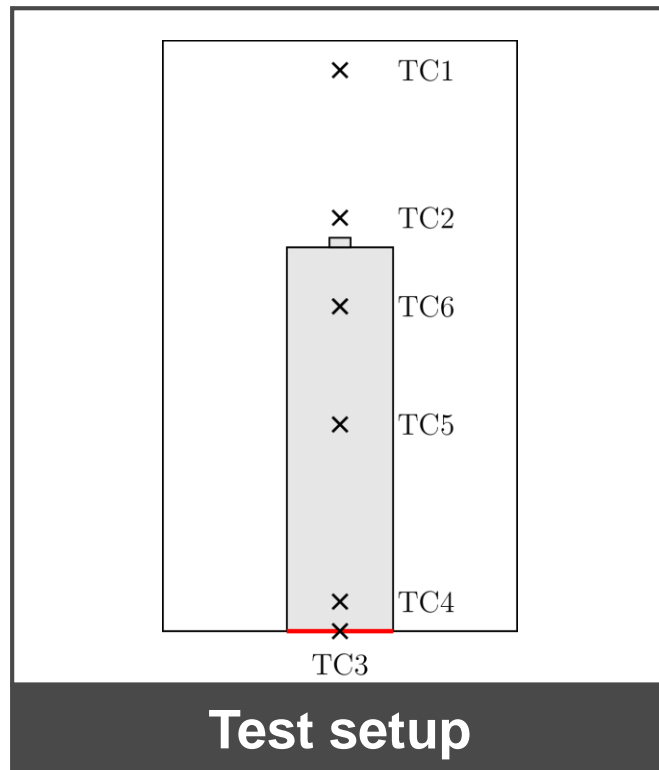

Overheat test of a single battery cell

18650 battery cell

fully charged
overheating at bottom

Overheat test of a single battery cell

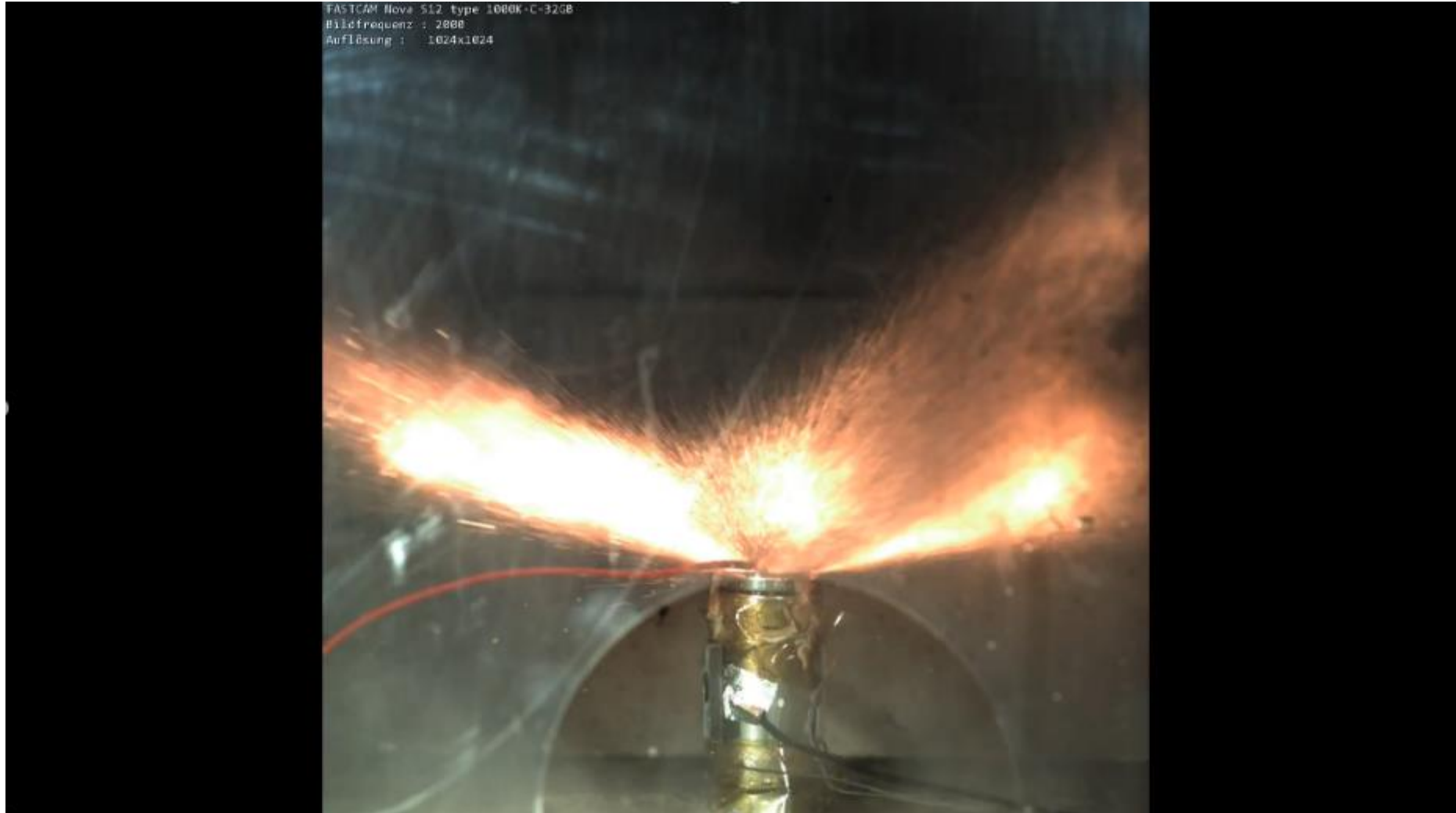

Overheat test of a single battery cell

Experimental results

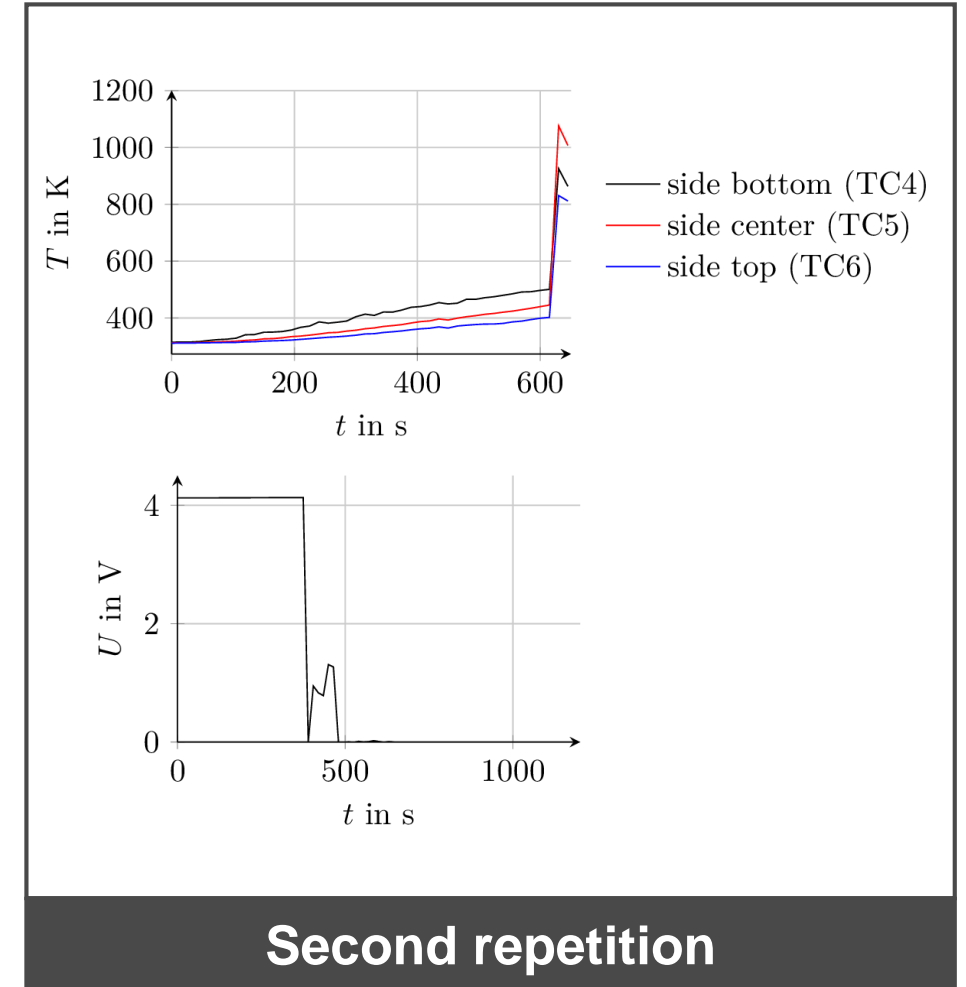
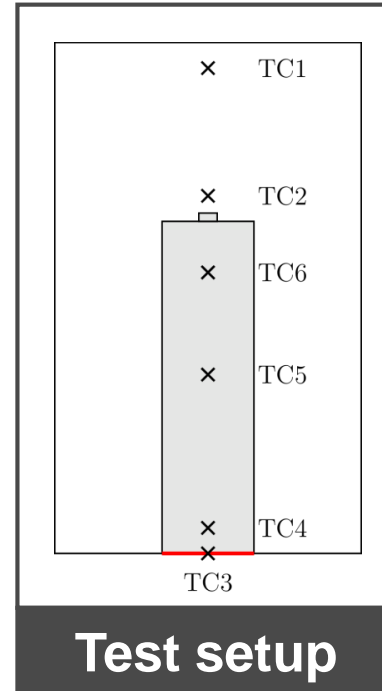
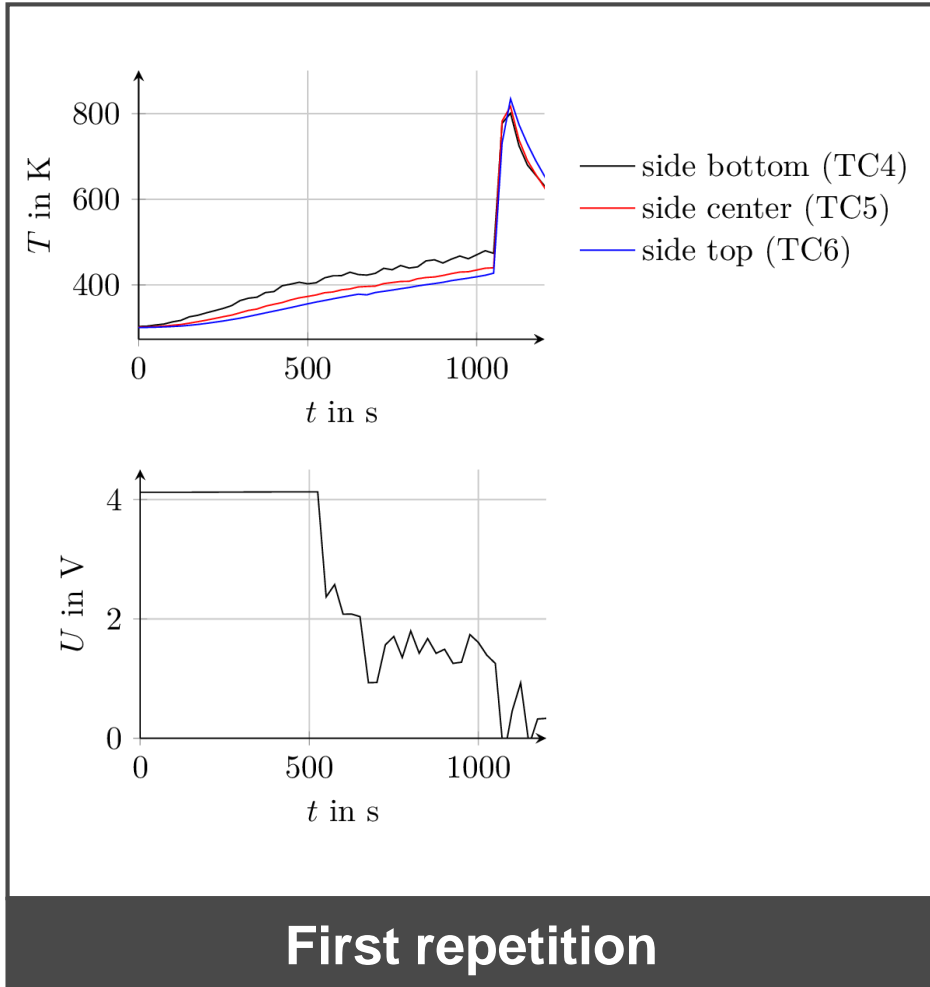

Overheat test of a single battery cell

Comparison of experimental and simulative data

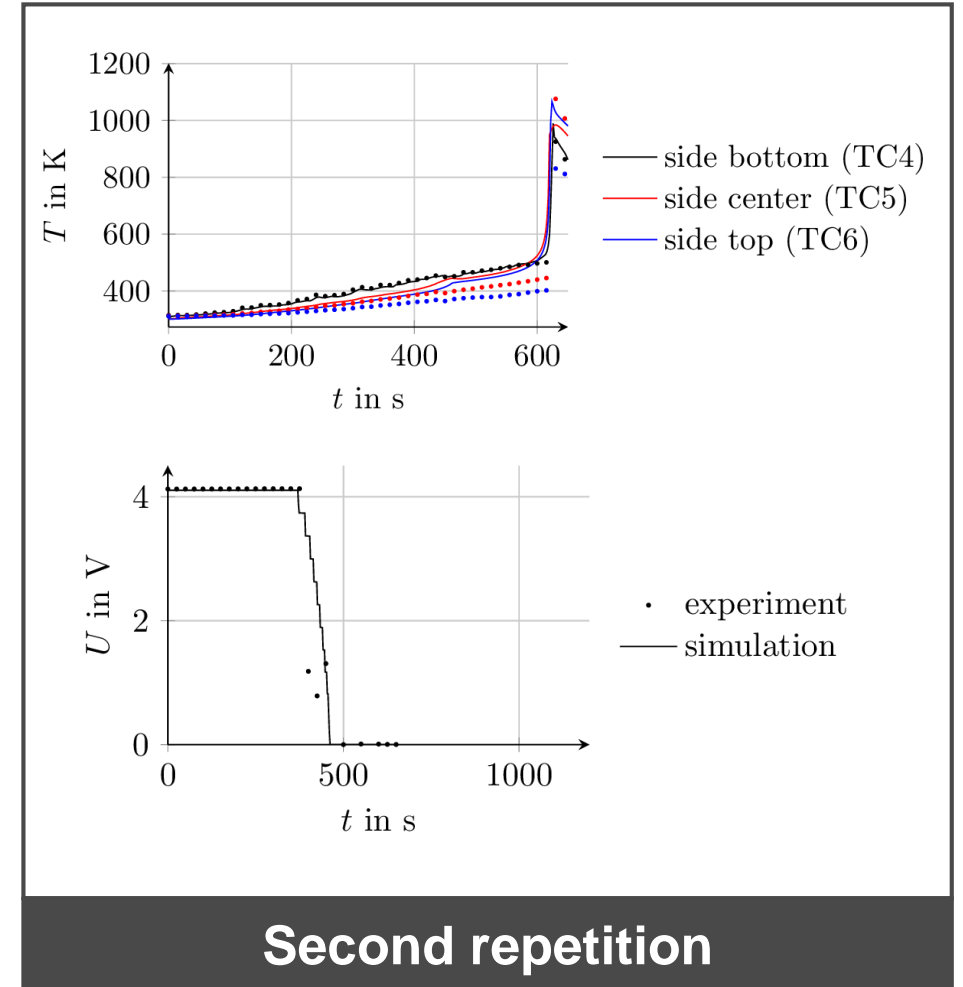
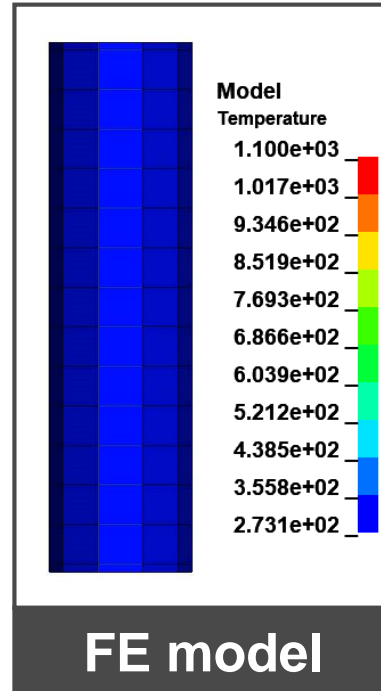
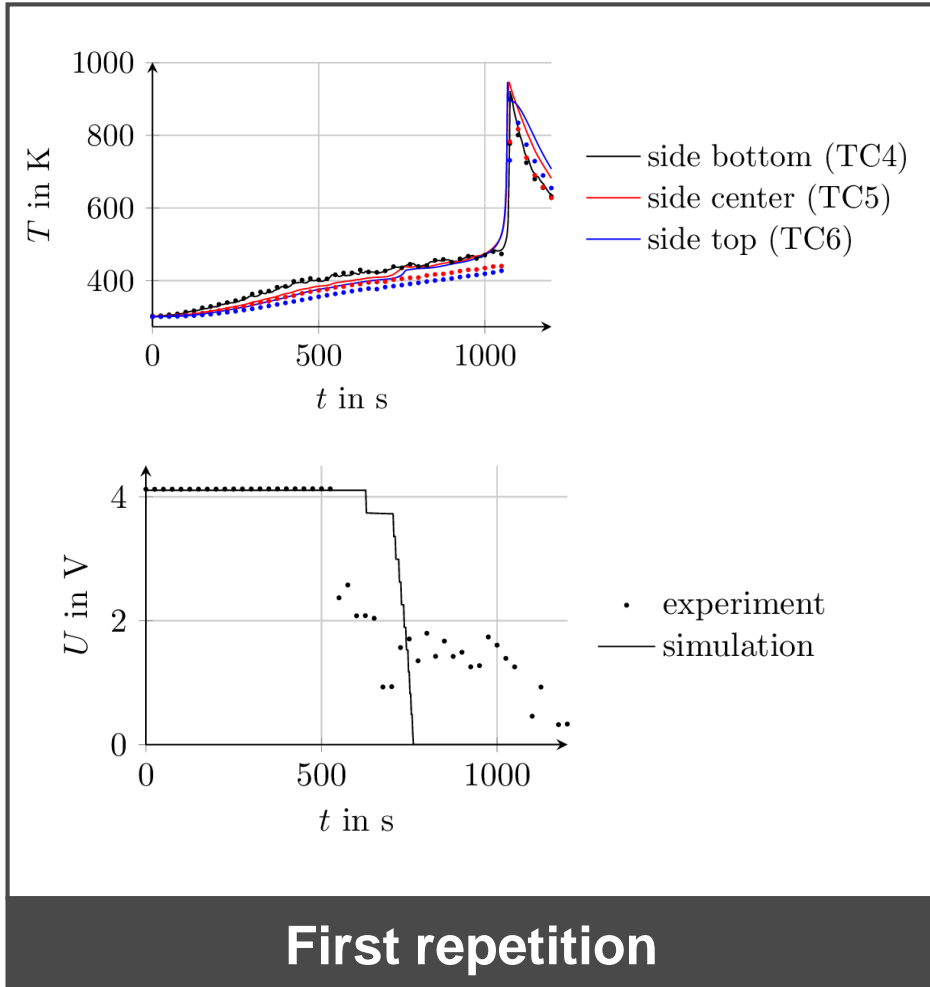

Application of a single cell model within the simulation of multi-cell mockups

Mockup with equal distances

Experimental investigation

- Thermal runaway of the center cell induced by heating with a heating wire
- Temperature and voltage measurement at each cell
- Video recording with high-speed camera

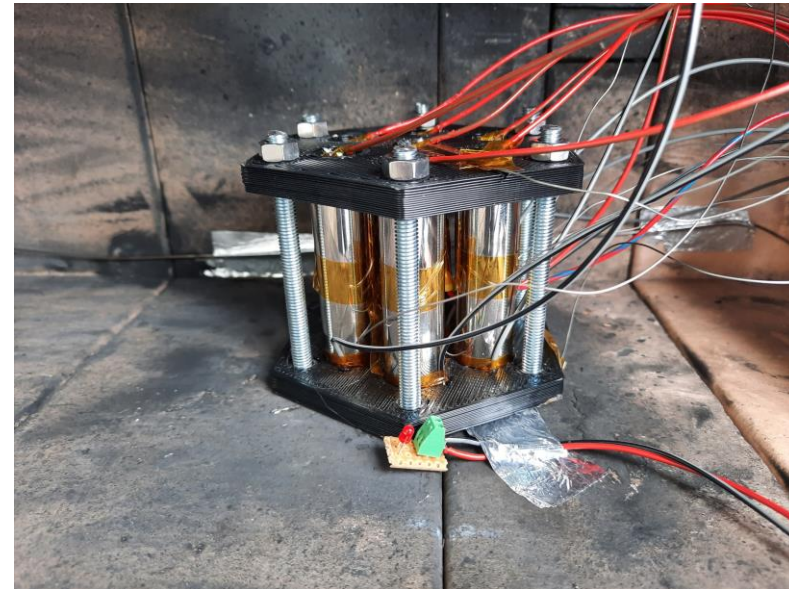
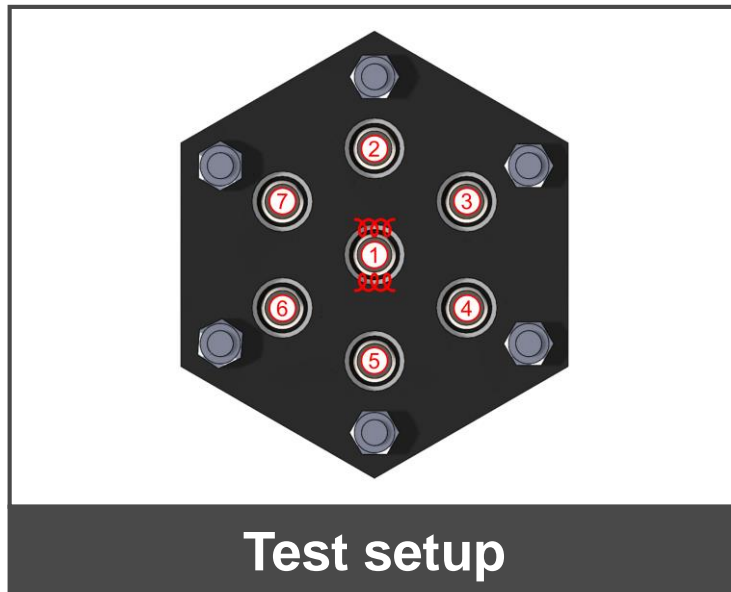

Mockup with equal distances

Experimental investigation

Mock-up with seven 18650 battery cells
equal distances

Mockup with equal distances

Experimental investigation



Mockup with equal distances

Experimental investigation – behavior of all cells

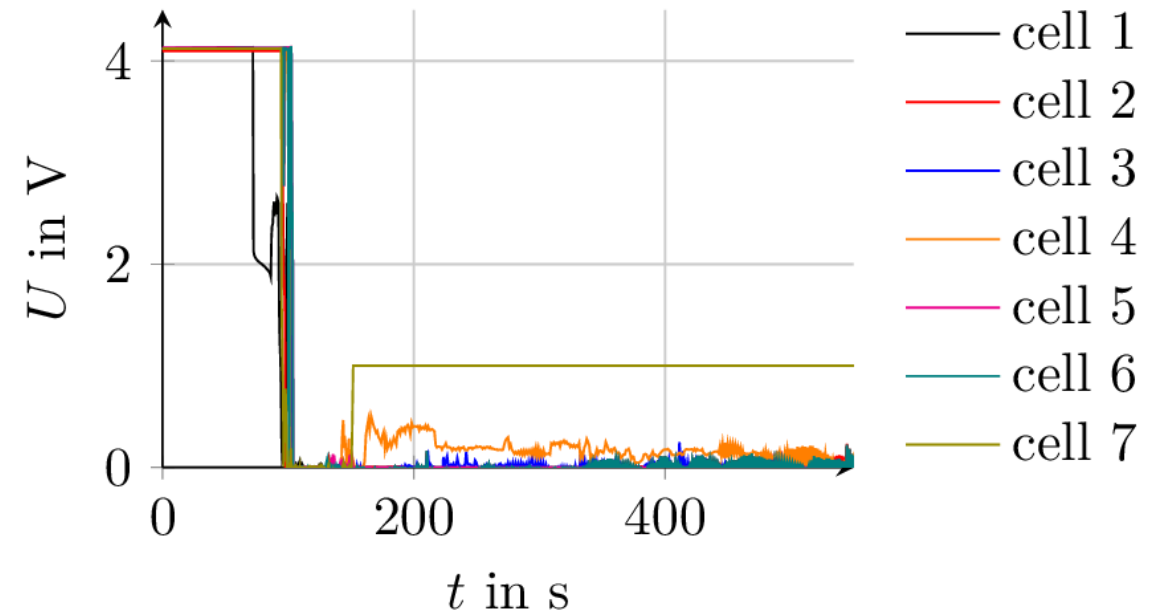
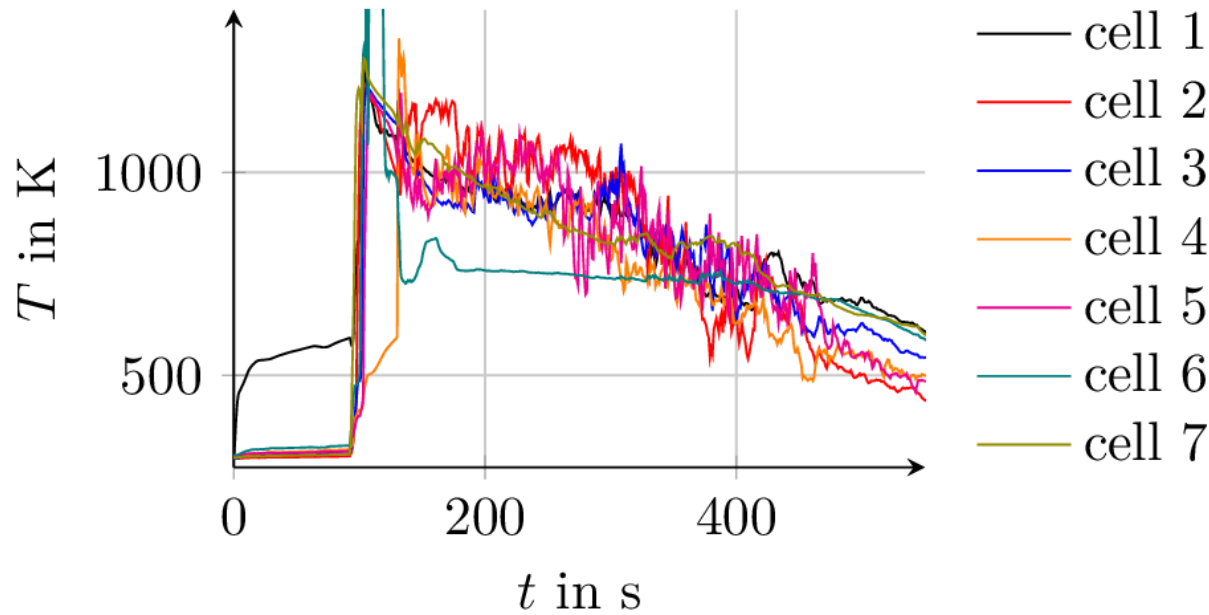
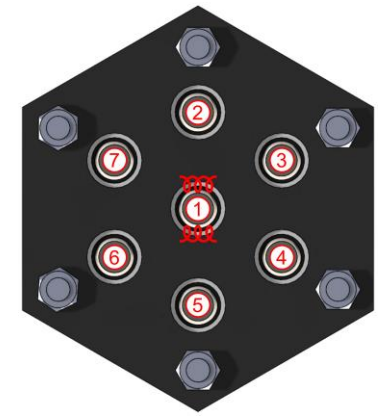

*Thermocouple at cell 6 was broken within the test

Mockup with equal distances

Experimental investigation – behavior of all cells

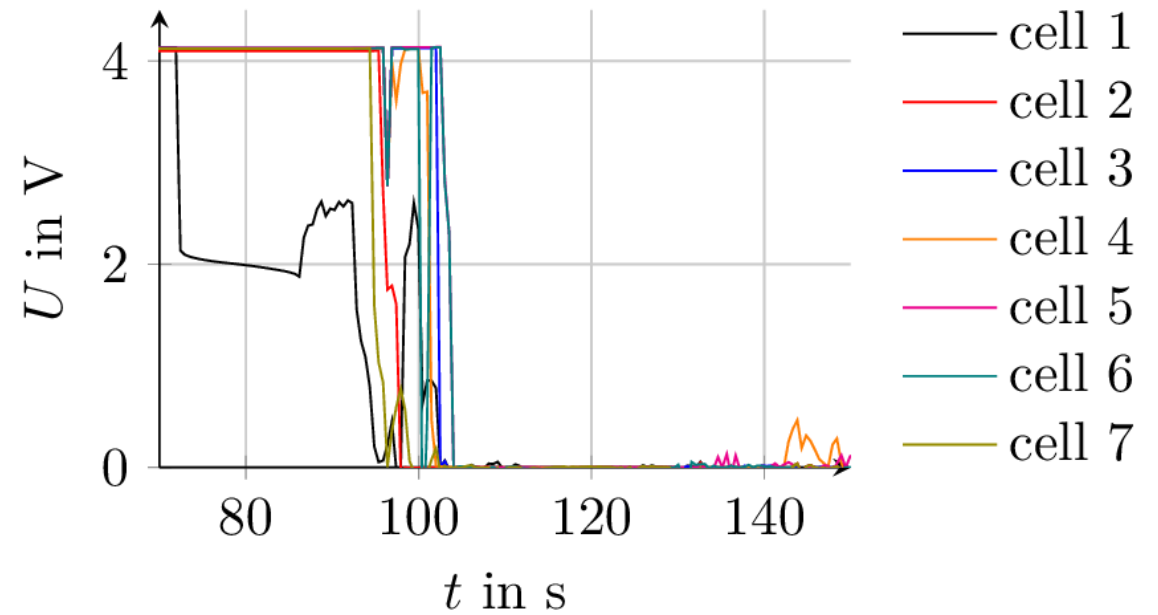
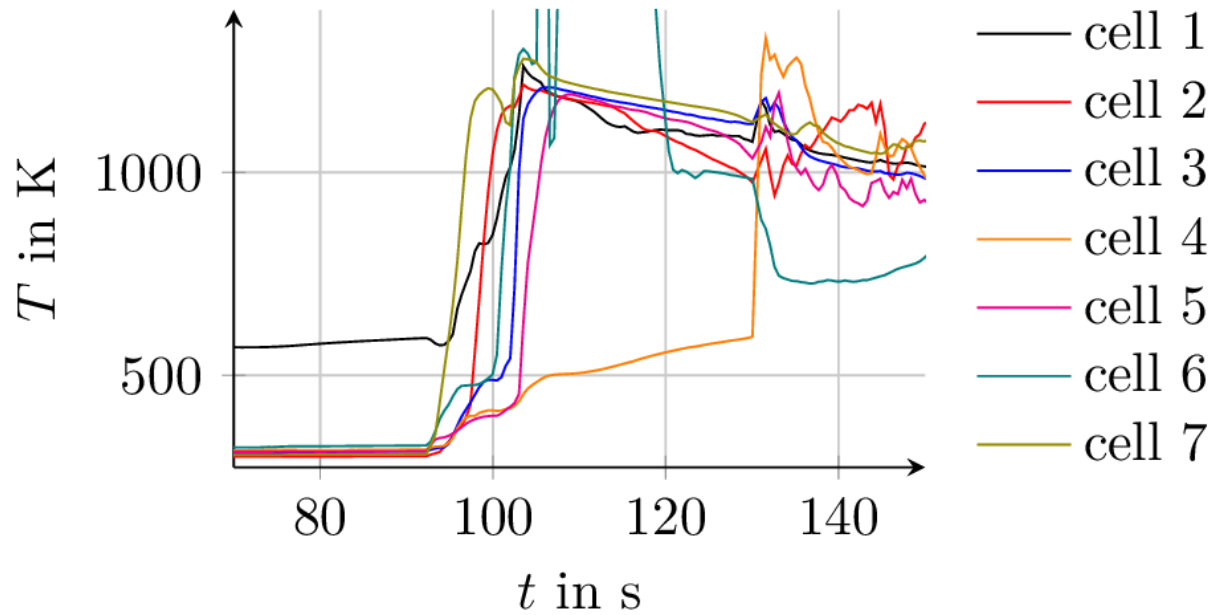
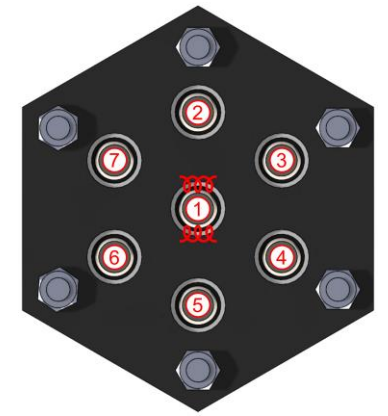

*Thermocouple at cell 6 was broken within the test

Mockup with equal distances

Experimental investigation – behavior of cell 1 and 2

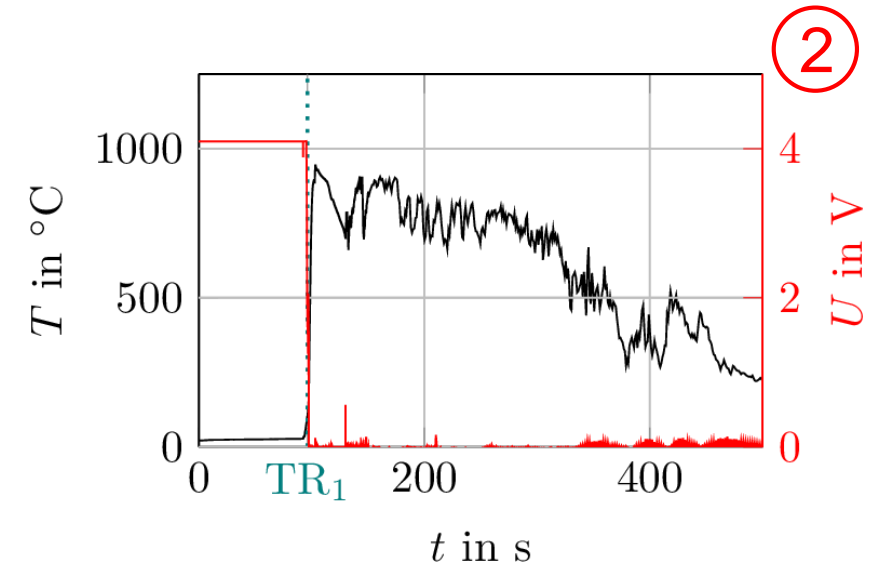
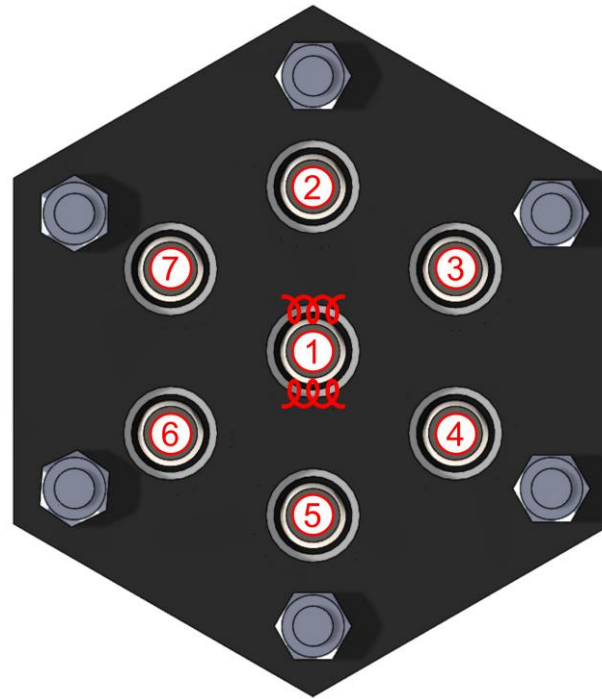
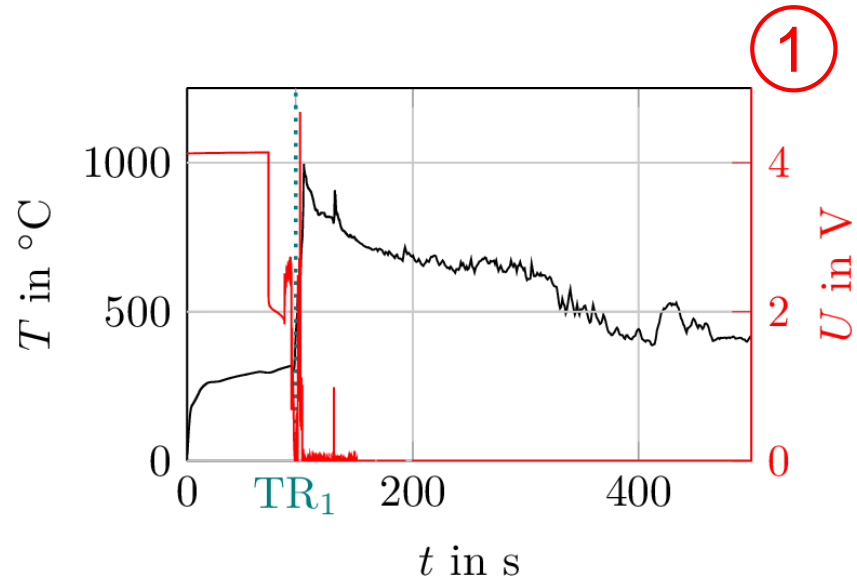

Mockup with equal distances

Simulation results

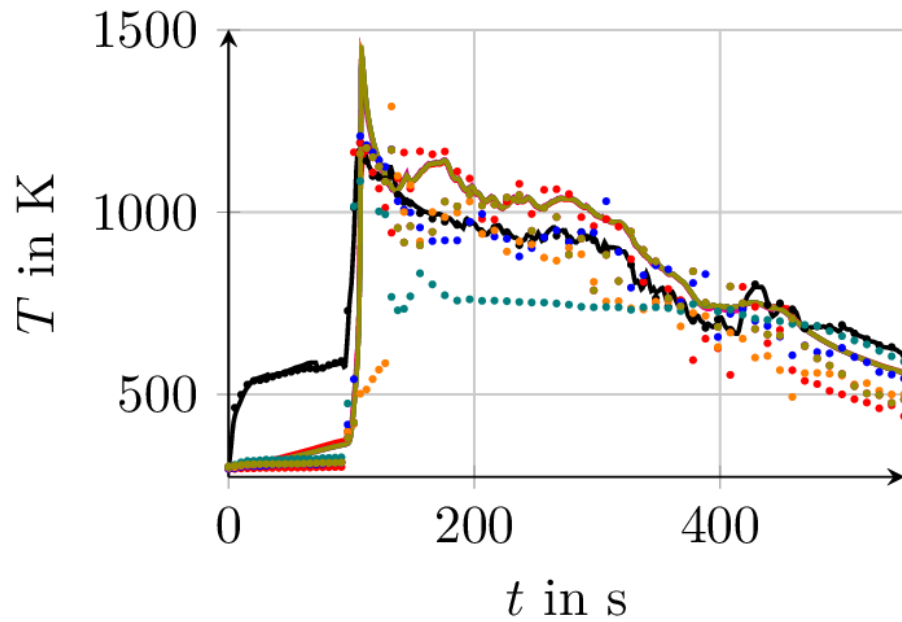
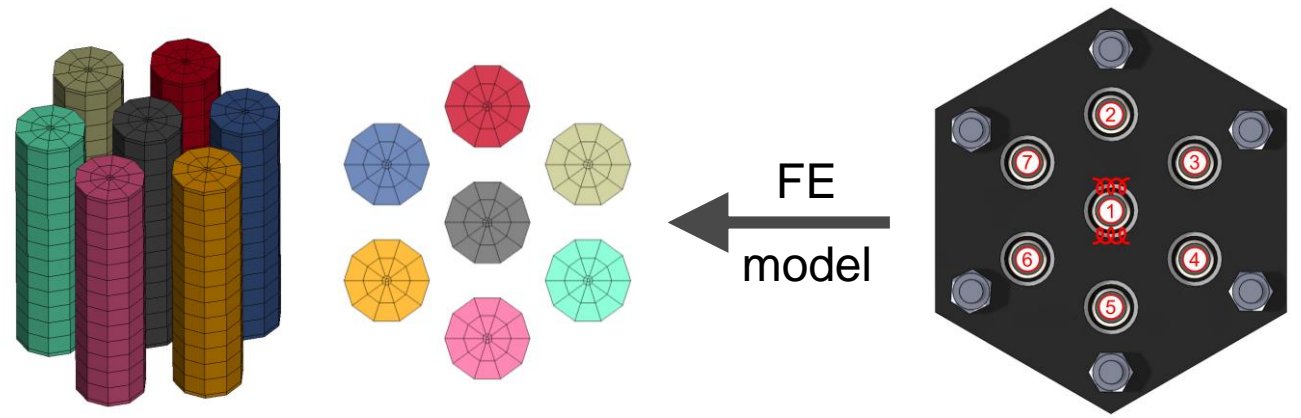

- cell 1
- cell 2
- cell 3
- cell 4
- cell 5
- cell 6
- cell 7

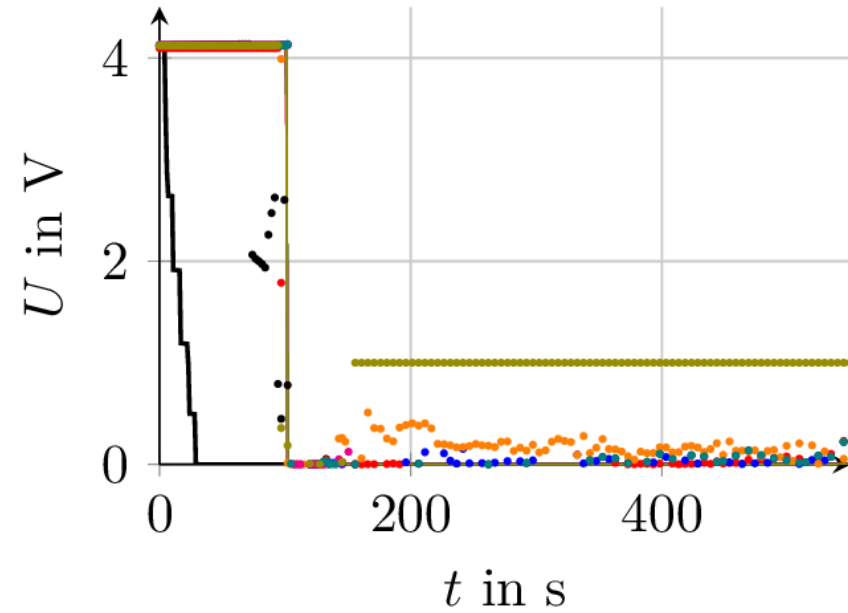

- cell 1
- cell 2
- cell 3
- cell 4
- cell 5
- cell 6
- cell 7

• experiment — simulation

Mockup with different distances

Experimental investigation

- Thermal runaway of the center cell induced by heating with a heating wire
- Temperature and voltage measurement at each cell
- Video recording with high-speed camera

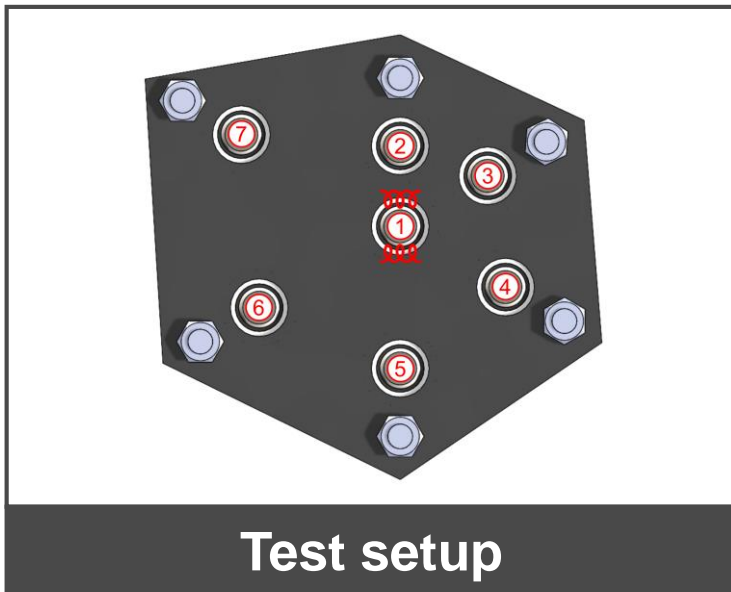

Mockup with different distances

Experimental investigation

Mock-up with seven 18650 battery cells
different distances

Mockup with different distances

Experimental investigation – behavior of all cells

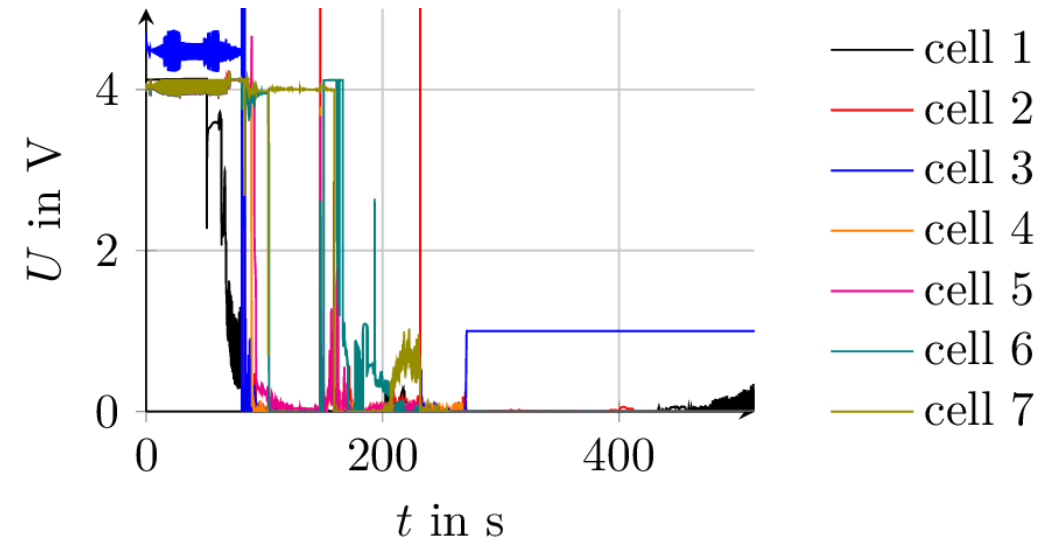
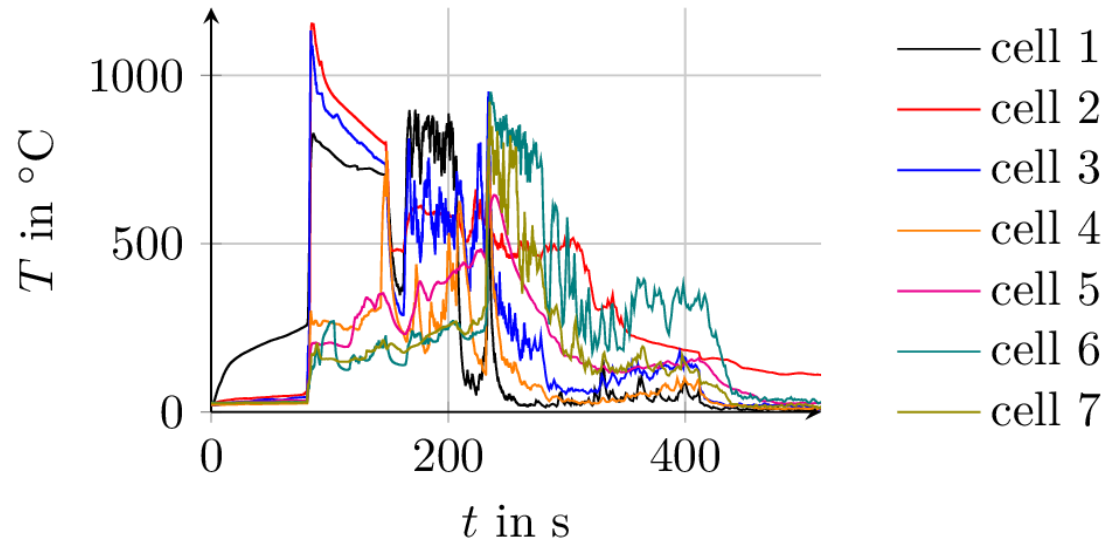
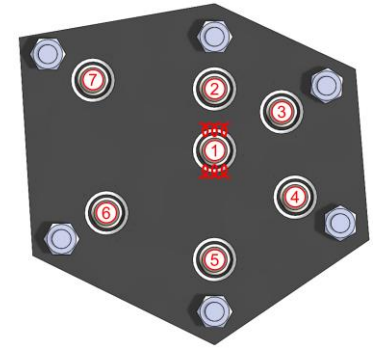

Mockup with different distances

Experimental investigation – behavior of all cells

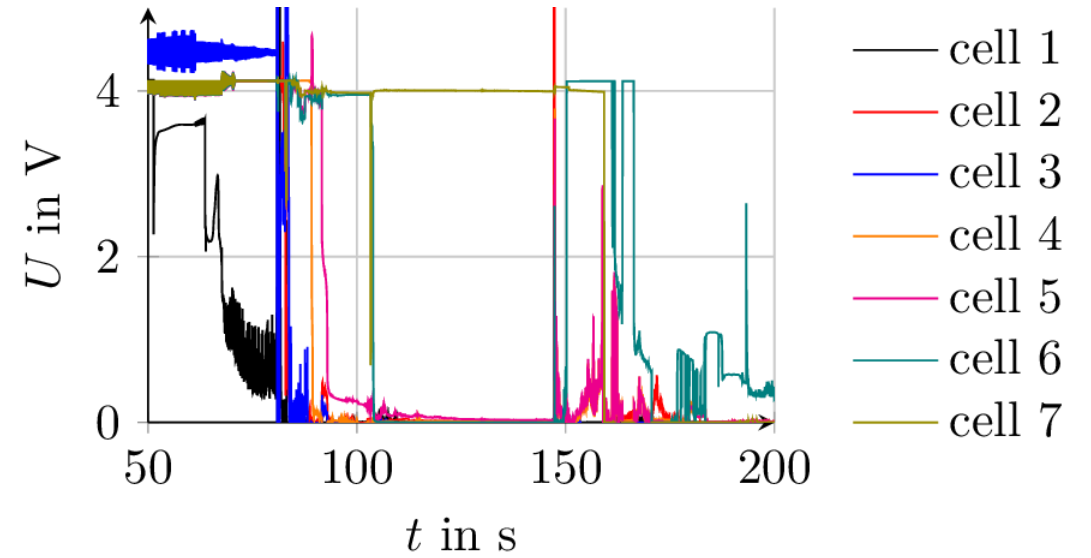
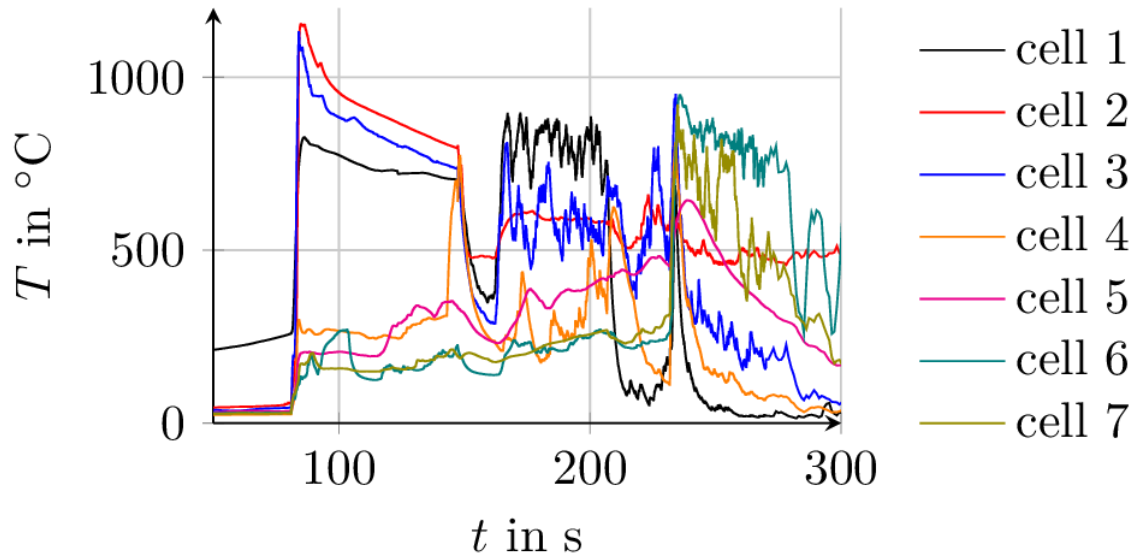
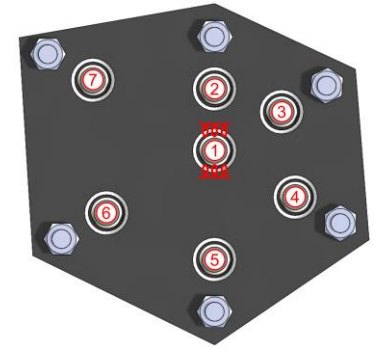

Mockup with different distances

Simulation results

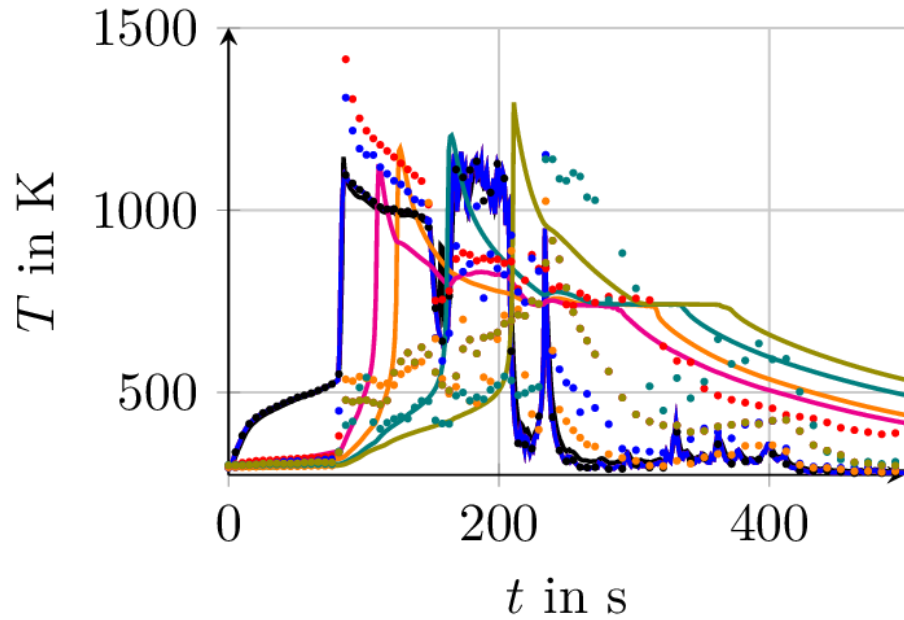
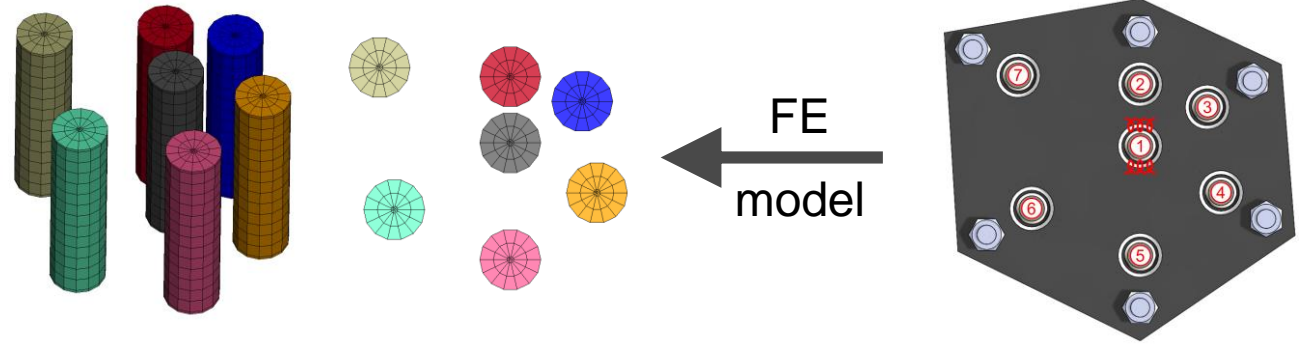

- cell 1
- cell 2
- cell 3
- cell 4
- cell 5
- cell 6
- cell 7

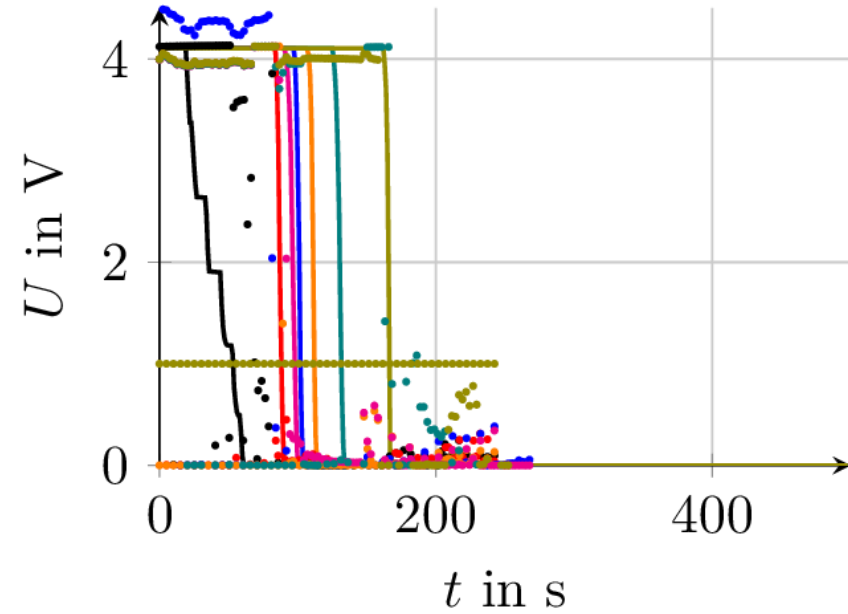

- cell 1
- cell 2
- cell 3
- cell 4
- cell 5
- cell 6
- cell 7

• experiment — simulation

Conclusion and outlook

Conclusion

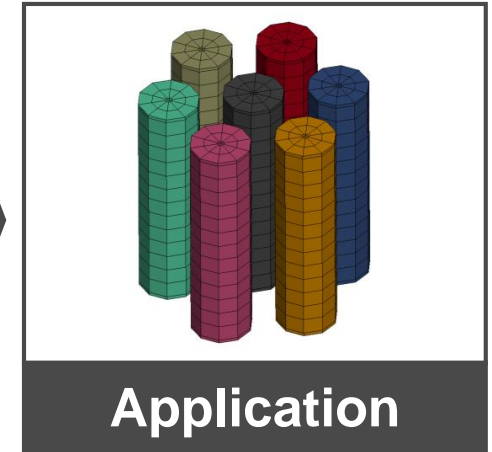
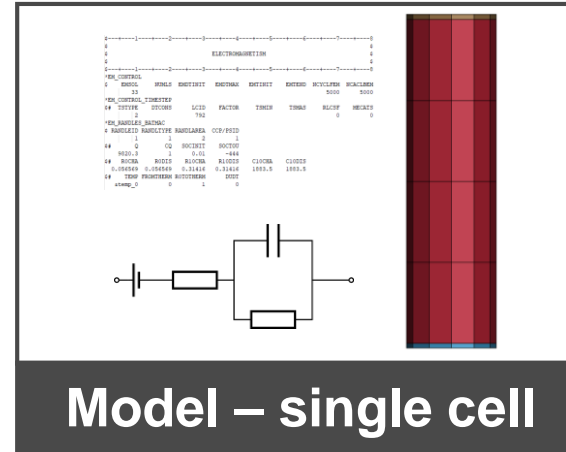
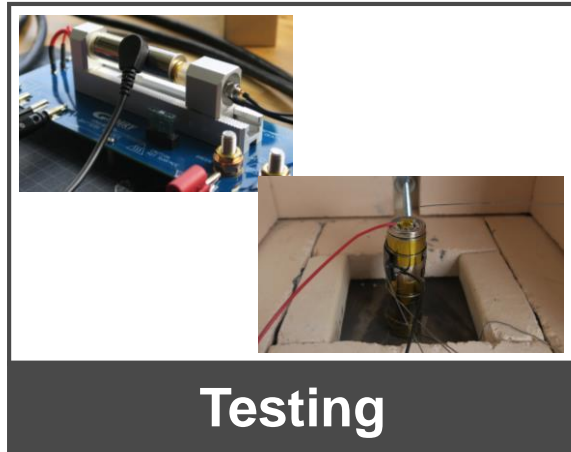

Outlook

- Development of test setups for further characterizations of battery cells especially within the thermal runaway
- Automatic identification of the parameters required for the resulting FE model
- Optimization of battery packs addressing the thermal propagation behavior

Conclusion

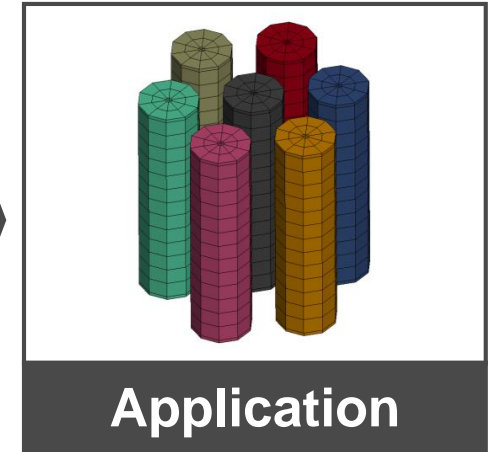
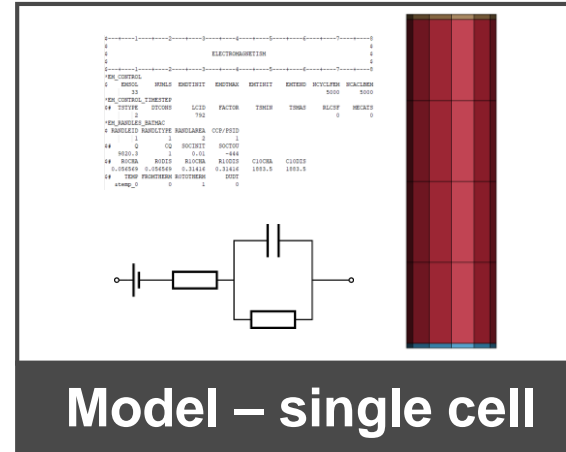
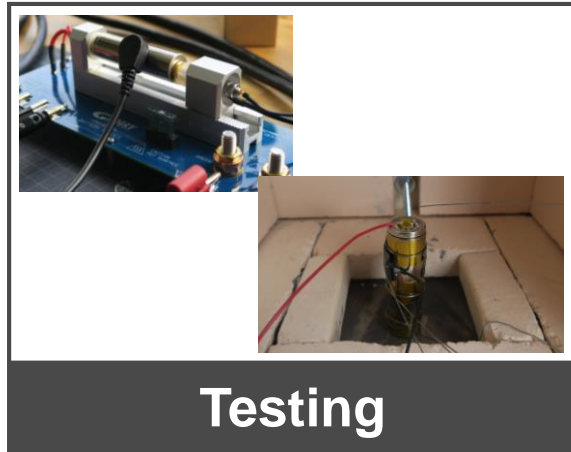

Outlook

- Development of test setups for further characterizations of battery cells especially within the thermal runaway
- Automatic identification of the parameters required for the resulting FE model
- Optimization of battery packs addressing the thermal propagation behavior

Improve your developments with our expertise in testing and simulation!

Martin Schwab



martin.schwab@4a.at

+43 (664) 80106 640

